

Varenummer: 437900068

Beskrivelse: Rota-fix spændelement SA 68

Mål

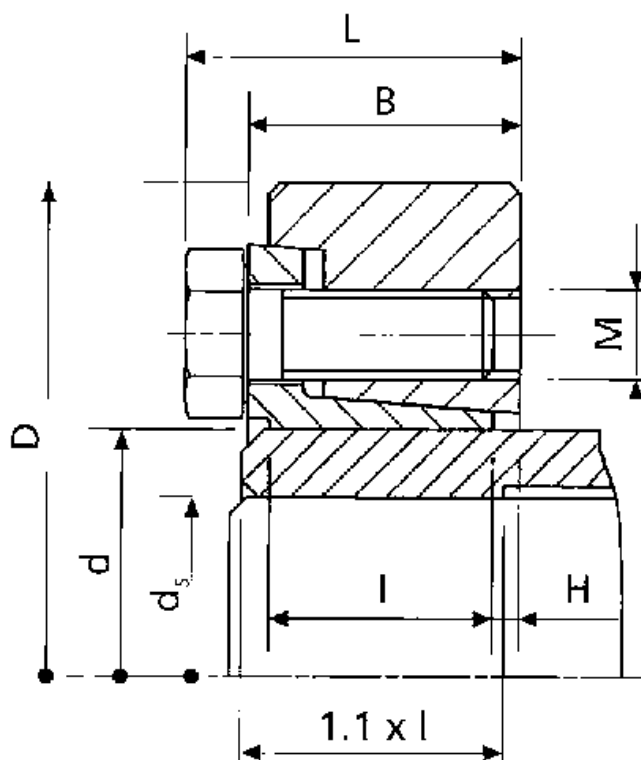

B mm	= 29.5
d H8 mm	= 68
D mm	= 115.0
ds mm	= 50
F kN aksialkraft	= 76
H	= 3.5
I mm	= 24.5
L mm	= 35.0

M mm	= M8
T Nm drejningsmoment	= 1900
Ts Nm boltetilspændingsmoment	= 30